



SXRSANES
Anesthesia

SXRSANES (ANESTHESIA CART) includes:

- 45"H (1136mm) Mobile Shell with Mechanical Keylock (2 keys)
- (4) 6" (152mm) Polymer Drawers
- (1) 9" (229mm) Polymer Drawer
- Taupe Drawer Pulls
- Left Swingout Locking Pod with (3) Tilt Bins (Keylock/2 keys)
- Right Swingout Locking Pod with (3) Tilt Bins (Keylock/2 keys)
- Overbridge with (2) Rails
- Universal Clamp
- Laryngoscope Blade/Specimen Holder
- Half-Size Metal Utility Bin
- Full-Size Metal Utility Bin
- (3) Label/Tape Dispensers
- (6) Plastic Utility Bins w/Clear Covers
- Overall Dimensions: 44.7"H (1136mm) x 34.7"W (882mm) x 24.9"D (633mm)



SXRSANES2
Anesthesia

Note: Taupe Pulls on Actual

SXRSANES2 (ANESTHESIA CART) includes:

- 45"H (1136mm) Mobile Shell with Electronic Keypad Lock & Backup Mechanical Keylock (2 keys)
- (4) 6" (152mm) Polymer Drawers
- (1) 9" (229mm) Polymer Drawer
- Taupe Drawer Pulls (Actual)
- Left Swingout Locking Pod with (3) Tilt Bins (Keylock/2 keys)
- Right Swingout Locking Pod with (3) Tilt Bins (Keylock/2 keys)
- Overbridge with (2) Rails
- Universal Clamp
- Laryngoscope Blade/Specimen Holder
- Half-Size Metal Utility Bin
- Full-Size Metal Utility Bin
- (3) Label/Tape Dispensers
- (6) Plastic Utility Bins w/Clear Covers
- Overall Dimensions: 44.7"H (1136mm) x 34.7"W (882mm) x 24.9"D (633mm)



SXRSARTH
Arthroscopic

SXRSARTH (ARTHROSCOPIC CART) includes:

- 45"H (1136mm) Mobile Shell with Mechanical Keylock (2 keys)
- (4) 6" (152mm) Polymer Drawers
- (1) 9" (229mm) Polymer Drawer
- Taupe Drawer Pulls
- Left Swingout Pod with Top Locking Tilt Bin (Keylock/2 keys)
- Sharps Container Bracket
- Right Swingout Non-Locking Pod
- Podtray with Dividers
- Tiltout Bin
- Waste Basket & Holder
- Overbridge with (2) Rails
- Wire Supply Basket
- (6) Plastic Utility Bins w/Clear Covers
- Overall Dimensions: 44.7"H (1136mm) x 34.7"W (882mm) x 24.9"D (633mm)



SXSBED
Bedside Cart

SXRSBED (BEDSIDE CART) includes:

- 45"H Mobile Shell with Mechanical Keylock (2 keys)
- (4) 3" (76mm) Polymer Drawers
- (2) 6" (152mm) Polymer Drawers
- (1) 9" (229mm) Polymer Drawer
- (1) 3" Drawer Divider Kit
- Pink Drawer Pulls

Left Fixed Pod

Chart Holder

Tiltout Bin

Right Fixed Pod with (3) Locking Tilt Bins

Overall Dimensions: 44.7"H (1136mm) x 34.7"W (882mm) x 24.9"D (633mm)



SXRSBIO
Biomedical Cart

SXRSBIO (BIOMEDICAL CART) includes:

- 48"H (1212mm) Non-Locking Mobile Shell
- (1) 3" (76mm) Polymer Drawer
- (1) 6" (152mm) Polymer Drawer
- (3) 9" (229mm) Polymer Drawers
- Slate Blue Drawer Pulls

Left Swingout Non-Locking Pod

Pod Tray w/Dividers

(3) Tilt Bins

Right Swingout Non-Locking Pod

Pod Tray w/Dividers

(3) Tilt Bins

Overbridge with Shelf & Accessory Rail

Utility/IV Pole & Clamp

Overall Dimensions: 47.7"H (1212mm) x 34.7"W (882mm) x 24.9"D (633mm)



SXRSCAST
Cast Cart

SXRSCAST (CAST CART) includes:

- 48"H (1212mm) Non-Locking Mobile Shell
- (2) 3" (76mm) Polymer Drawers
- (2) 6" (152mm) Polymer Drawers
- (2) 9" (229mm) Polymer Drawers
- Slate Blue Drawer Pulls

(1) 3" Drawer Divider Kit

Left Swingout Non-Locking Pod

Pod Tray w/Dividers

(3) Tilt Bins

Right Fixed Non-Locking Pod

Pod Tray w/Dividers

(1) Tilt Bin

Waste Basket & Holder

Overbridge with (2) Accessory Rails

Wire Supply Basket

Overall Dimensions: 47.7"H (1212mm) x 34.7"W (882mm) x 24.9"D (633mm)



SXRSCLINE
Central Line Cart

SXRSCLINE (CENTRAL LINE CART) includes:

- 42"H (1060mm) Mobile Shell with Electronic Keypad Lock & Backup
- Mechanical Keylock (2 keys)
- Full-Extension Keyboard Tray
- (3) 3" (76mm) Polymer Drawers
- (2) 6" (152mm) Polymer Drawers
- (1) 9" (229mm) Polymer Drawer
- (2) 3" Drawer Divider Kits
- (1) 6" Drawer Divider Kit
- Taupe Drawer Pulls
- Left Swingout Pod with Top-Locking Tilt Bin (Keylock/2 keys)
- Lockable Sharps Container & Glove Box Holder
- Right Swingout Pod with Top-Locking Tilt Bin (Keylock/2 keys)
- Waste Basket & Holder
- Overall Dimensions: 41.7"H (1060mm) x 22.7"W (577mm) x 24.9"D (633mm)



SXRSCMPBED
Computer-Ready Bedside Cart

SXRSCMPBED (COMPUTER-READY BEDSIDE CART) includes:

- 42"H (1060mm) Mobile Shell with Mechanical Keylock (2 keys)
- Full-Extension Keyboard Tray
- (2) 3" (76mm) Polymer Drawers
- (2) 6" (152mm) Polymer Drawers
- (1) 9" (229mm) Polymer Drawer
- Slate Blue Drawer Pulls
- Hospital Grade 6-Outlet Power Strip with Cord Wrap
- 3" Diameter Cord Management Grommet w/Cover
- Articulating Laptop Arm
- Overall Dimensions: 41.7"H (1060mm) x 22.7"W (577mm) x 24.9"D (633mm)



SXRSCCU
Critical Care Cart

SXRSCCU (CRITICAL CARE CART) includes:

- 48"H N (1212mm) on-Locking Mobile Shell
- (1) 3" (76mm) Polymer Drawer
- (1) 6" (152mm) Polymer Drawer
- (3) 9" (229mm) Polymer Drawers
- Slate Blue Drawer Pulls
- (1) 3" Drawer Divider Kit
- Left Swingout Non-Locking Pod
- Pod Tray w/Dividers
- (3) Tilt Bins
- Right Fixed Non-Locking Pod
- Pod Tray w/Dividers
- (1) Tilt Bin
- Waste Basket & Holder
- Overbridge with Shelf & Accessory Rail
- Wire Supply Basket
- (6) Blue Plastic Utility Bins w/Clear Covers
- Overall Dimensions: 47.7"H (1212mm) x 34.7"W (882mm) x 24.9"D (633mm)



SXRSDCMED
Decentralized Medication Cart

SXRSDCMED (DECENTRALIZED MEDICATION CART) includes:
 45"H (1136mm) Mobile Shell with Mechanical Keylock (2 keys)
 (1) 3" (76mm) Polymer Drawer with Locking Cover (Keylock/2 keys)
 (3) 3" (76mm) Polymer Drawer
 (2) 6" (152mm) Polymer Drawer
 (1) 9" (229mm) Polymer Drawer
 Taupe Drawer Pulls
Left Swingout Pod with Top-Locking Tilt Bin (Keylock/2 keys)
 Waste Basket & Holder
Right Swingout Pod with (3) Locking Tilt Bins (Keylock/2 keys)
Overbridge with (2) Rails
 Half-Size Metal Utility Bin
 Label/Tape Dispenser
 Wire Supply Basket
 (6) Plastic Utility Bins w/Clear Covers
Overall Dimensions: 44.7"H (1136mm) x 34.7"W (882mm) x 24.9"D (633mm)



SXRSDRS
Dressing Cart

SXRSDRS (DRESSING CART) includes:
 42"H (1060mm) Mobile Shell with Mechanical Keylock (2 keys)
 (3) 3" (76mm) Polymer Drawers
 (2) 6" (152mm) Polymer Drawers
 (1) 9" (229mm) Polymer Drawer
 Taupe Drawer Pulls
Overall Dimensions: 41.7"H (1060mm) x 22.7"W (577mm) x 24.9"D (633mm)



SXRISISO
Isolation Cart

SXRISISO (ISOLATION CART) includes:
 42"H (1060mm) Mobile Shell with Mechanical Keylock (2 keys)
 (2) 6" (152mm) Polymer Drawers
 (2) 9" (229mm) Polymer Drawers
 Yellow Drawer Pulls
 IV Pole
Overall Dimensions: 41.7"H (1060mm) x 22.7"W (577mm) x 24.9"D (633mm)



SXRSIV
I.V. Therapy Cart

- SXRSIV (I.V. THERAPY CART)** includes:
- 45"H Mobile Shell with Mechanical Keylock (2 keys)
 - (5) 3" (76mm) Polymer Drawers
 - (2) 9" (229mm) Polymer Drawers
 - Green Drawer Pulls
 - (4) 3" Drawer Divider Kits
 - Left Swingout Pod with 3 Locking Tilt Bins (Keylock/2 keys)
 - Pod Tray with Dividers
 - Right Swingout Pod with 3 Locking Tilt Bins (Keylock/2 keys)
 - Pod Tray with Dividers
 - IV Pole
 - Overall Dimensions: 44.7"H (1136mm) x 34.7"W (882mm) x 24.9"D (633mm)



SXRSMDSRG
Med Surg Cart

- SXRSMDSRG (MED SURG CART)** includes:
- 42"H (1060mm) Mobile Shell with Mechanical Keylock (2 keys)
 - (1) 3" (76mm) Polymer Drawer
 - (3) 6" (152mm) Polymer Drawers
 - (1) 9" (229mm) Polymer Drawer
 - Green Drawer Pulls
 - (1) 3" Drawer Divider Kit
 - Overall Dimensions: 41.7"H (1060mm) x 22.7"W (577mm) x 24.9"D (633mm)



SXRSTRAMA
Trauma Cart

- SXRSTRAMA (TRAUMA CART)** includes:
- 45"H (1136mm) Mobile Shell with Mechanical Keylock (2 keys)
 - (3) 3" (76mm) Polymer Drawers
 - (4) 6" (152mm) Polymer Drawers
 - (2) 3" Drawer Divider Kits
 - Slate Blue Drawer Pulls
 - Left Swingout Pod with Top-Locking Tilt Bin (Keylock/2 keys)
 - Pod Tray with Dividers
 - Waste Basket & Holder
 - Right Swingout Pod with Top-Locking Tilt Bin (Keylock/2 keys)
 - (1) Middle non-locking Tilt Bin
 - (1) Sharps Container Bracket
 - Overbridge with (1) Shelf & (1) Rail
 - Utility/IV Pole & Clamp
 - Wire Supply Basket
 - Overall Dimensions: 44.7"H (1136mm) x 34.7"W (882mm) x 24.9"D (633mm)



SXRSUDOSE
Unit Dose Medication Cart

SXRSUDOSE (UNIT DOSE MEDICATION CART) includes:

- 45"H (1136mm) Mobile Shell with Electronic Touchpad & Backup Mechanical Keylock (2 keys)
- (1) 4-Level Medication Cassette (Keylock/2 keys)
- (6) 3" Cassette Bins
- (8) 4" Cassette Bins
- (3) 6" Cassette Bins
- (1) 3" (76mm) Polymer Drawer with Locking Cover (Keylock/2 keys)
- (1) 6" (152mm) Polymer Drawer
- (1) 9" (229mm) Polymer Drawer
- (1) 3" Drawer Divider Kit
- Slate Blue Drawer Pulls
- Left Swingout Pod
- Pod Shelf & Cup Holder
- Waste Basket & Holder
- Right Swingout Pod with Top-Locking Tilt Bin (includes Pod Tray & Dividers) (Keylock/2 keys)
- (1) Sharps Container Bracket
- Overall Dimensions: 44.7"H (1136mm) x 34.7"W (882mm) x 24.9"D (633mm)



SXRS43CM4
Note: Taupe Pulls on Actual

SXRS43CM4 includes:

- 45"H (1136mm) Mobile Shell with Mechanical Keylock (2 keys)
- (4) 3" (76mm) Polymer Drawers
- (2) 6" (152mm) Polymer Drawers
- (1) 9" (229mm) Polymer Drawer
- (2) 3" Drawer Divider Kits
- Taupe Drawer Pulls (Actual)
- Left Swingout Locking Pod (Keylock/2 keys)
- (3) Tiltout Bins
- Right Fixed Pod
- Waste Basket & Holder
- Overall Dimensions: 44.7"H (1136mm) x 22.7"W (577mm) x 24.9"D (633mm)



SXRS43CM6

SXRS43CM6 includes:

- 45"H (1136mm) Mobile Shell
- Passive Lock Security System
- Bag of 100 Red Security Seals
- (2) 3" (76mm) Polymer Drawers
- (3) 6" (152mm) Polymer Drawers
- (1) 9" (229mm) Polymer Drawer
- Slate Blue Drawer Pulls
- Left Swingout Non-Locking Pod
- Pod Shelf
- Sharps Container Bracket
- Waste Basket & Holder
- Right Swingout Non-Locking Pod
- (3) Tilt Bins
- Overall Dimensions: 44.7"H (1136mm) x 34.7"W (882mm) x 24.9"D (633mm)



SXRS40CM1

SXRS40CM1 includes:
 42"H (1060mm) Mobile Shell
Passive Lock Security System
 Bag of 100 Red Security Seals
 (1) 3" (76mm) Polymer Drawer
 (3) 6" (152mm) Polymer Drawers
 (1) 9" (229mm) Polymer Drawer
 Slate Blue Drawer Pulls
Overall Dimensions: 41.7"H (1060mm) x 22.7"W (577mm) x 24.9"D (633mm)



SXRS43CM1

SXRS43CM1 includes:
 45"H (1136mm) Non-Locking Mobile Shell
 (1) 6" (152mm) Polymer Drawers
 (3) 9" (229mm) Polymer Drawer
 Taupe Drawer Pulls
Overall Dimensions: 44.7"H (1136mm) x 22.7"W (577mm) x 24.9"D (633mm)



SXRS43CM3

SXRS43CM3 includes:
 45"H (1136mm) Non-Locking Mobile Shell
 (4) 3" (76mm) Polymer Drawers
 (2) 6" (152mm) Polymer Drawers
 (1) 9" (229mm) Polymer Drawer
 Taupe Drawer Pulls
Overall Dimensions: 44.7"H (1136mm) x 22.7"W (577mm) x 24.9"D (633mm)



SXRS1310L

SXRS1310L includes:
 42" H (1060mm) Mobile Shell with Mechanical Keylock (2 keys)
 (1) 3" (76mm) Polymer Drawer
 (3) 6" (152mm) Polymer Drawers
 (1) 9" (229mm) Polymer Drawer
 Taupe Drawer Pulls
Overall Dimensions: 41.7"H (1060mm) x 22.7"W (577mm) x 24.9"D (633mm)



SXRS3210L

SXRS3210L includes:

42" H (1060mm) Mobile Shell with Mechanical Keylock (2 keys)

(3) 3" (76mm) Polymer Drawers

(2) 6" (152mm) Polymer Drawers

(1) 9" (229mm) Polymer Drawer

Taupe Drawer Pulls

Overall Dimensions: 41.7"H (1060mm) x 22.7"W (577mm) x 24.9"D (633mm)



SXRS5510L

SXRS5510L includes:

42"H (1060mm) Mobile Shell with Mechanical Keylock (2 keys)

(5) 3" (76mm) Polymer Drawers

(1) 6" (152mm) Polymer Drawer

(1) 9" (229mm) Polymer Drawer

Taupe Drawer Pulls

Overall Dimensions: 41.7"H (1060mm) x 22.7"W (577mm) x 24.9"D (633mm)



SXRS1220L

SXRS1220L includes:

45"H (1136mm) Mobile Shell with Mechanical Keylock (2 keys)

(1) 3" (76mm) Polymer Drawer

(2) 6" (152mm) Polymer Drawers

(2) 9" (229mm) Polymer Drawers

Taupe Drawer Pulls

Overall Dimensions: 44.7"H (1136mm) x 22.7"W (577mm) x 24.9"D (633mm)



SXRS4210L

SXRS4210L includes:

45"H (1136mm) Mobile Shell with Mechanical Keylock (2 keys)

(4) 3" (76mm) Polymer Drawers

(2) 6" (152mm) Polymer Drawers

(1) 9" (229mm) Polymer Drawer

Taupe Drawer Pulls

Overall Dimensions: 44.7"H (1136mm) x 22.7"W (577mm) x 24.9"D (633mm)



SXRS6110L

SXRS6110L includes:
 45"H (1136mm) Mobile Shell with Mechanical Keylock (2 keys)
 (6) 3" (76mm) Polymer Drawers
 (1) 6" (152mm) Polymer Drawer
 (1) 9" (229mm) Polymer Drawer
 Taupe Drawer Pulls
Overall Dimensions: 44.7"H (1136mm) x 22.7"W (577mm) x 24.9"D (633mm)



SXRS0320L

SXRS0320L includes:
 48"H (1212mm) Mobile Shell with Mechanical Keylock (2 keys)
 (3) 6" (152mm) Polymer Drawers
 (2) 9" (229mm) Polymer Drawers
 Taupe Drawer Pulls
Overall Dimensions: 47.7"H (1212mm) x 22.7"W (577mm) x 24.9"D (633mm)



SXRS2220L

SXRS2220L includes:
 48"H (1212mm) Mobile Shell with Mechanical Keylock (2 keys)
 (2) 3" (76mm) Polymer Drawers
 (2) 6" (152mm) Polymer Drawers
 (2) 9" (229mm) Polymer Drawers
 Taupe Drawer Pulls
Overall Dimensions: 47.7"H (1212mm) x 22.7"W (577mm) x 24.9"D (633mm)



SXRS3310L

SXRS3310L includes:
 48"H (1212mm) Mobile Shell with Mechanical Keylock (2 keys)
 (3) 3" (76mm) Polymer Drawers
 (3) 6" (152mm) Polymer Drawers
 (1) 9" (229mm) Polymer Drawer
 Taupe Drawer Pulls
Overall Dimensions: 47.7"H (1212mm) x 22.7"W (577mm) x 24.9"D (633mm)



SXRSDIFAIR
Difficult Airway Cart

SXRSDIFAIR (DIFFICULT AIRWAY CART) includes:

54"H (1372mm) Mobile Shell with Passive Security Lockbar,
Security Drawer Tabs & Bag of 100 Security Seals
Extended Base Rotated 90° to the Right

(7) 6" (152mm) Polymer Drawers

(7) Drawer Divider Kits

(20) Label Holders

Slate Blue Drawer Pulls

Left Side

(2) Side Accessory Brackets

(1) 19" Peel Pouch Holder

(1) 28" Peel Pouch Holder

Right Side

(2) Side Accessory Brackets

Gas Tank Holder

Gas Tank Regulator Bracket

2-Scope Side-Mount Cabinet w/Locking Clear Door/2-keys

Overall Dimensions: 57.8"H (1469 mm) x 31"W (788mm) x 24"D (610mm)



SXRIVSTOR
Secure I.V. Cart

SXRIVSTOR (SECURE I.V. CART) includes:

60"H (1517mm) Mobile Shell

Clear 225° Right-Hinged Locking Door (Keylock/2 keys)

Slate Blue Door Pull

(3) Full-Extension Chrome Wire Shelves

(3) White Tote Boxes: 17 ½ x 22 ½ x 8" (384 x 514 x 203mm)

Overall Dimensions: 59.7"H (1517mm) x 22.7"W (577mm) x 27.9"D (709mm)



SXRDIVSTOR
Secure I.V. Cart

SXRDIVSTOR (SECURE I.V. CART) includes:

60"H (1517mm) Double-Wide Mobile Shell

Clear 225° Center-Closing Locking Door Set (Keylock/2 keys)

Slate Blue Door Pulls

(3) Double-Wide Full-Extension Chrome Wire Shelves

(6) White Tote Boxes: 17 ½ x 22 ½ x 8" (384 x 514 x 203mm)

Overall Dimensions: 59.7"H (1517mm) x 42 ½" W (1080mm) x 27.9"D (709mm)



SXRD43CM3

SXRD43CM3 includes:

45"H (1136mm) Double-Bay Non-Locking Mobile Shell

(4) 3" (76mm) Polymer Drawers

(6) 6" (152mm) Polymer Drawers

(2) 9" (229mm) Polymer Drawers

Slate Blue Pulls

Overall Dimensions: 44.7"H (1136mm) x 42.5"W (1080mm) x 24.9"D (633mm)



SXRDGS4

SXRDGS4 includes:

45"H (1136mm) Double-Bay Mobile Shell

Left Bay

(3) 3" (76mm) Polymer Drawers

(1) 6" (152mm) Polymer Drawer

(2) 9" (229mm) Polymer Drawers

Right Bay

(2) Poly Shelves

Solid 270° Right-Hinged Non-Locking Door

Slate Blue Pulls

Overall Dimensions: 44.7"H (1136mm) x 42.5"W (1080mm) x 24.9"D (633mm)



SXRD43CM4

SXRD43CM4 includes:

45"H Double-Wide, Single-Bay Mobile Shell

(2) Fixed Chrome Wire qwikSLOT Shelves

Solid 270° Center-Closing Non-Locking Door Set

Slate Blue Door Pulls

Overall Dimensions: 44.7"H (1136mm) x 42.5"W (1080mm) x 27.9"D (709mm)

Standard Drawer Tote Specs

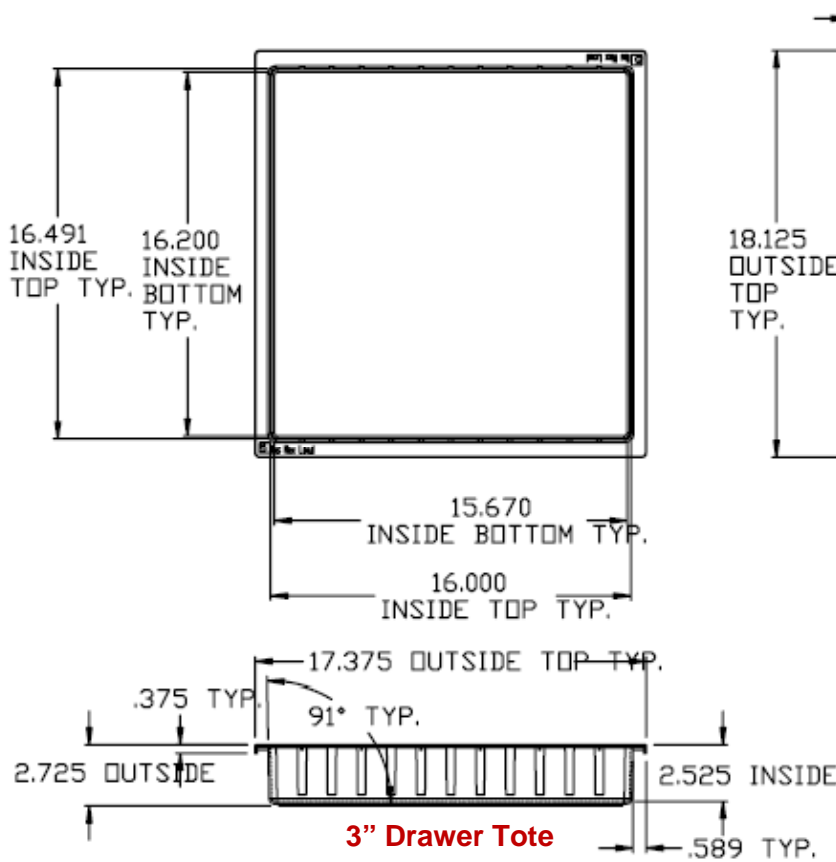

3" Drawer Tote

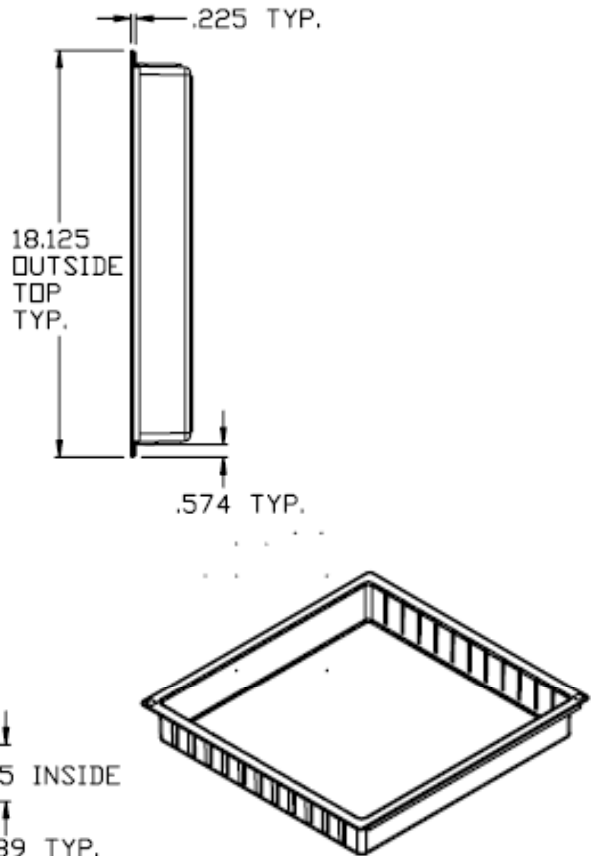

3" Drawer Tote

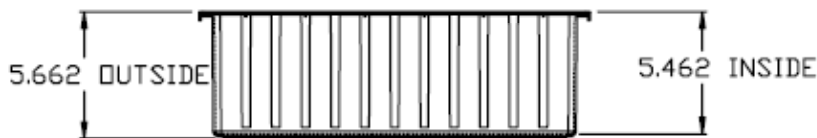

6" Drawer Tote

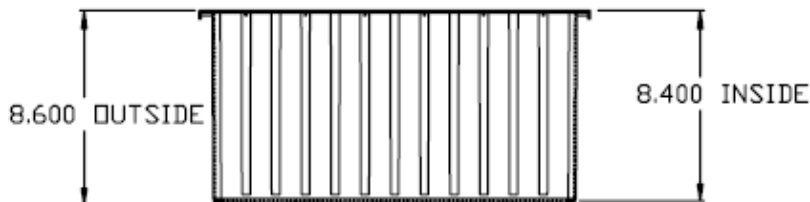

9" Drawer Tote



Weight Capacities:
 3" Tote = 25 lbs. (11.3Kg)
 6" & 9" Totes = 40 lbs. (18.1 Kg)

Heavy Duty Drawer Specs



Above: Double-Wide 3" Heavy Duty Drawer

Left: Single-Wide Heavy Duty Drawers

Inside Dimensions Metro Part #	Inches			Millimeters			Wt Capacity	
	H	W	D	H	W	D	Lbs	Kg
Single-Wide HD Drawers								
3" Heavy Duty Dwr	2.3	16.3	19.2	58	414	487	100	45.4
6" Heavy Duty Dwr	5.3	16.3	19.2	134	414	487	100	45.4
9" Heavy Duty Dwr	8.3	16.3	19.2	210	414	487	100	45.4
12" Heavy Duty Dwr	11.5	16.3	19.2	292	414	487	100	45.4
Double-Wide HD Drawers								
3" Heavy Duty Dwr	2.3	36.3	19.2	58	922	487	150	68
6" Heavy Duty Dwr	5.3	36.3	19.2	134	922	487	150	68
9" Heavy Duty Dwr	8.3	36.3	19.2	210	922	487	150	68
12" Heavy Duty Dwr	11.5	36.3	19.2	292	922	487	150	68

Construction: The drawer interior is composed of 16 and 18 gauge solid stainless steel. The drawer slides are full-extension, zinc-plated steel with chrome-plated ball bearings, and attach to qwikSLOT inserts. They have side lever releases and detents in the closed position. The slide travel distance is 20.75". The drawer front surface is composed of molded ABS polymer, colored in Metro Taupe. Snap-on handles ("pulls") attach above the top recessed area and are available in a variety of colors. Optional self-adhesive label holders positioned in the recessed area under the pulls are also offered.

STARSYS™

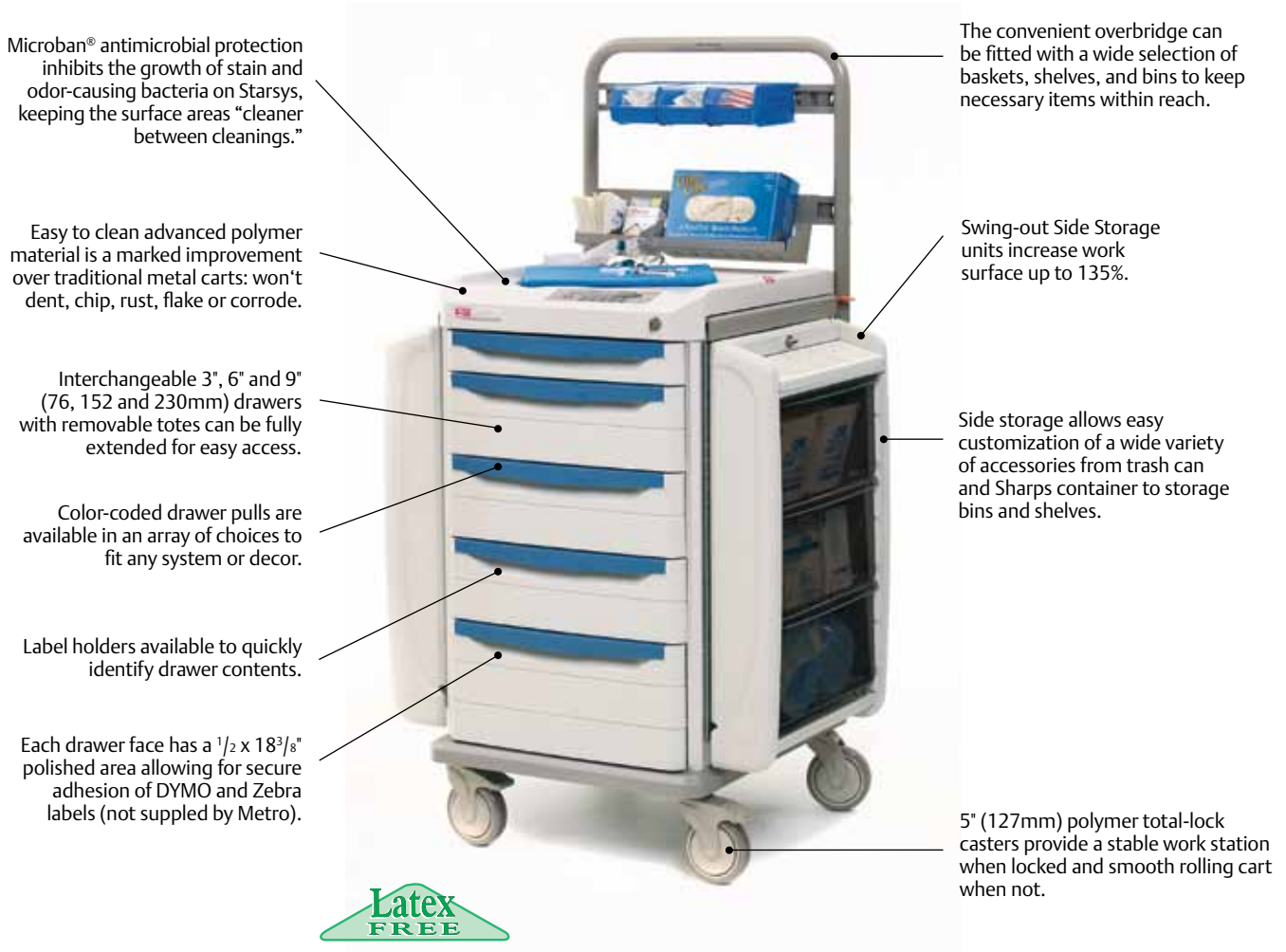

Microban® antimicrobial protection inhibits the growth of stain and odor-causing bacteria on Starsys, keeping the surface areas “cleaner between cleanings.”

Easy to clean advanced polymer material is a marked improvement over traditional metal carts: won't dent, chip, rust, flake or corrode.

Interchangeable 3", 6" and 9" (76, 152 and 230mm) drawers with removable totes can be fully extended for easy access.

Color-coded drawer pulls are available in an array of choices to fit any system or decor.

Label holders available to quickly identify drawer contents.

Each drawer face has a 1/2 x 18 3/8" polished area allowing for secure adhesion of DYMO and Zebra labels (not supplied by Metro).

The convenient overbridge can be fitted with a wide selection of baskets, shelves, and bins to keep necessary items within reach.

Swing-out Side Storage units increase work surface up to 135%.

Side storage allows easy customization of a wide variety of accessories from trash can and Sharps container to storage bins and shelves.

5" (127mm) polymer total-lock casters provide a stable work station when locked and smooth rolling cart when not.



Starsys Carts

Starsys provides a complete system of enclosed carts in a wide variety of heights and system widths. When mobility is a key part of your storage needs, Starsys carts provide a broad selection of unique solutions. This modular system approach allows you to create a cart to meet your exact needs.

Starsys cart widths and depth:

The Starsys cart system is built upon a square module. Multiplying this storage module results in system widths of single 22 3/4" (578mm), double 42 1/2" (1080mm) and triple 62 1/2" (1588mm) widths. The depth on all carts is 24.9" (632mm).

Starsys cart heights:

Starsys carts are available in the following working heights: 36" (907mm), 39" (983mm), 42" (1060mm), 45" (1136mm) and 48" (1212mm)

General Overview:

Starsys carts feature 5" (127mm) polymer swivel casters. The front two casters have a Total-Lock Toe Brake (locks both the wheel and the horn).

Starsys carts feature a smooth polymer top/worksurface. If chemical resistance is a concern or heavy equipment is likely to be placed on the top of the cart, Starsys Mobile WorkCenters may be a more appropriate product selection.

An extended mobile base is required when Heavy-Duty drawers, Active Level shelving or qwikSLOT shelving is specified in a Starsys configuration. The extended mobile base adds an additional 3" (76mm) to the overall depth of the cart. The extended base combines additional counter weights with a deeper footprint to reduce any chance of overbalance when active level shelving is fully extended.

To configure a Starsys unit to your exact specifications, please visit www.metroconfigurator.com

42"

Close-up of system



General Supply with Passive Security
Cat. No. **SXRS40CM1**



Isolation
Cat. No. **SXRSISO**



Med Surg
Cat. No. **SXRSMDSRG**



Dressing
Cat. No. **SXRSDRS**

45"



Bedside Cart
Cat. No. **SXRS43CM1**



Bedside
Cat. No. **SXRSBED**



Computer Ready Bedside Cart
Cat. No. **SXRCOMPBED**



Anesthesia
Cat. No. **SXRSANES**



Central Line Cart
Cat. No. **SXRSCLINE**



Decentralized Medication
Cat. No. **SXRSDCMED**



Arthroscopic
Cat. No. **SXRSARTH**



I.V. Therapy
Cat. No. **SXRSIV**



Unit Dose Medication
Cat. No. **SXRSUDOSE**



Trauma
Cat. No. **SXRSTRAMA**

Starsys Carts are built to exact customer specifications, therefore, they are non-cancelable, non-returnable.

48"



Biomedical
Cat. No. **SXRSBIO**



Critical Care
Cat. No. **SXRSCCU**



Cast
Cat. No. **SXRSCAST**



Difficult Airway Cart
Cat. No. **SXRSIFAIR**

Basic Single Wide, Locking Carts

(in.)	(mm)	Drawer Configuration	Cat. No.
24 ⁷ / ₈ x22 ³ / ₄ x41 ³ / ₄	1061x578x1061	1-3", 3-6", 1-9", 0-12"	SXRS1310L
24 ⁷ / ₈ x22 ³ / ₄ x41 ³ / ₄	1061x578x1061	3-3", 2-6", 1-9", 0-12"	SXRS3210L
24 ⁷ / ₈ x22 ³ / ₄ x41 ³ / ₄	1061x578x1061	5-3", 1-6", 1-9", 0-12"	SXRS5110L
24 ⁷ / ₈ x22 ³ / ₄ x44 ³ / ₄	1137x578x1137	1-3", 2-6", 2-9", 0-12"	SXRS1220L
24 ⁷ / ₈ x22 ³ / ₄ x44 ³ / ₄	1137x578x1137	4-3", 2-6", 1-9", 0-12"	SXRS4210L
24 ⁷ / ₈ x22 ³ / ₄ x44 ³ / ₄	1137x578x1137	6-3", 1-6", 1-9", 0-12"	SXRS6110L
24 ⁷ / ₈ x22 ³ / ₄ x47 ³ / ₄	1213x578x1213	0-3", 3-6", 2-9", 0-12"	SXRS0320L
24 ⁷ / ₈ x22 ³ / ₄ x47 ³ / ₄	1213x578x1213	2-3", 2-6", 2-9", 0-12"	SXRS2220L
24 ⁷ / ₈ x22 ³ / ₄ x47 ³ / ₄	1213x578x1213	3-3", 3-6", 1-9", 0-12"	SXRS3310L

Carts shown in chart have taupe pulls.



SXRS3210L



SXRS3310L

Drawer Pulls (one required per drawer) To specify color for drawer pull, order following catalog numbers for each drawer:

Dark Taupe SXRDP-TP	White SXRDP-WH	Code Blue SXRDP-CB	Red SXRDP-RE	Orange SXRDP-OR	Green SXRDP-GR	Yellow SXRDP-YL	Slate Blue SXRDP-BL	Violet SXRDP-VL	Pink SXRDP-PK	Black SXRDP-BK

Tamper-Evident (Passive Security) Locks

Provides passive security for each drawer individually. Quick visual confirmation of broken seals indicates which drawers have been opened. Includes factory-installed lockbar, drawer locktabs permanently riveted to each drawer, and 100 security seals.

Description	Cat. No.
24" (610mm) Security Bar, Drawer Tabs & Seals	SXRPSLK-24
27" (686mm) Security Bar, Drawer Tabs & Seals	SXRPSLK-27
30" (762mm) Security Bar, Drawer Tabs & Seals	SXRPSLK-30
33" (839mm) Security Bar, Drawer Tabs & Seals	SXRPSLK-33
36" (914mm) Security Bar, Drawer Tabs & Seals	SXRPSLK-36

Mechanical Keylocks

The new M300 Series Keylocks have an "Ignition-Style" design to protect keys from bending or breaking. Mechanical keylocks are a good choice for all kinds of applications and work on all types of units and accessories – carts, cabinets, drawers, doors and wall cabinets. They are available as primary locks or as backups for other types of locking systems. Each lock includes a set of two keys. Extra keys available upon request.



M300 Series Keylock



Tamper-Evident Locks

To configure a Starsys unit to your exact specifications, please visit www.metroconfigurator.com



Starsys Carts — Security Options

Hinged Push-Button Lockbars

These versatile push button lockbars can be used to lock both drawers and doors. Because the push button mechanism is purely mechanical, no wiring, electronic or batteries are required. Each lockbar includes a backup M300 series keylock, 2 keys, and a passive security locktab (security seals ordered separately: LEC9900A = Bag of 100).

For Factory-Assembled Units

Description	Left Mounted Cat. No.	Right Mounted Cat. No.
24"H (610mm) Hinged Lockbar	SXRPBL24L	SXRPBL24R
27"H (686mm) Hinged Lockbar	SXRPBL27L	SXRPGL27R
30"H (762mm) Hinged Lockbar	SXRPBL30L	SXRPBL30R
33"H (839mm) Hinged Lockbar	SXRPBL33L	SXRPBL33R
36"H (914mm) Hinged Lockbar	SXRPBL36L	SXRPBL36R

For field retrofit of above key locking bars, add suffix **-KD** to above part numbers.

Electronic Push Button Locks ("EPBL" Locks)

The "EPBL" Lock is a simple push-button, battery-operated 4-digit code lock with a 10-digit push button face and 10-user programmable PIN numbers. Correctly entering a 4-digit code will allow a simple lock latch to be turned for access. Master, Sub-Master, User and Single Use functions. Power: (2) AAA Batteries.

Basic Electronic Keyless Entry Touchpad

A reliable, easy-to-operate electronic drawer locking system which operates entirely on six D-Cell batteries. No electrical plug-in or recharging is required.

Features:

- 250 User/Supervisor Codes (4-14 digits)
- Auto-Relock (programmable from 1 second)*
- Low Battery Indicator
- Non-volatile memory
- Panel-mount RJ11 port for audit trail download
- Optional user management software

Touchpads & Options

Description	Cat. No.
Basic Keyless Entry Touchpad with Auto Relock, Battery Operated	SCM2174*
Proximity Reader (order with Basic Touchpad)	SCM2178*
Magstripe Reader (order with Basic Touchpad)	SCM2179*
HID Proximity User Card	SCP1929
HID Proximity Supervisor Card	SCP1930
HID Proximity Tag	SCP1931
Magstripe User Card	SCP1932
Magstripe Supervisor Card	SCP1933
User Management Software Kit	SCP1934

*Readers may not be compatible with all cards. A sample card must be submitted to verify compatibility. Contact your Metro representative.

Electronic Touchpad Locking System

Our most advanced full-feature keyless electronic drawer locking system designed for use on single-, double- and triple-wide carts in heights from 36" to 48" tall.

Features:

- 2,000 User/Supervisor Codes
- Auto-relock with Motion Sensors
- Proximity & Magnetic Card Reader Options
- User Management/Audit Trail Software option
- Multiple Bay Security

Electronic Touchpads & Options

Description	Cat. No.
Keyless Entry Touchpad-Single Bay Locking	SX RTP-varies
Keyless Entry Touchpad-Double Bay Locking	SX RTP-varies
Keyless Entry Touchpad-Triple Bay Locking	SX RTP-111
User Management/Audit Trail Software	FL421
Charger/Voltage Adapter (for outside N. America)	SXR-INTLCHGR
Proximity Reader	SXR-PROXRDR*
Proximity User Card	SXR-UPROXCRD
Proximity Tag	SXR-PROXTAG
Magstripe Reader	SXR-MAGRDR*

*Readers may not be compatible with all cards. A sample card must be submitted to verify compatibility. Contact your Metro representative.



Hinged Lockbar



EPB Lock



Basic Keyless Entry Touchpad



Electronic Touchpad Locking System

Starsys Carts are built to exact customer specifications, therefore, they are non-cancelable, non-returnable.



Polymer Drawers and Accessories

Description	Inside Dimensions (Height/Width/Length) (in.)	Non-Locking Cat. No.	Locking Cat. No.
Polymer Drawers (Drawer pull required – see selection below)			
3" (76mm) SW Drawer	2 ³ / ₈ x16 ³ / ₈ x15 ⁷ / ₈	SXRS3	SXRS3-LK
4.5" (114mm) SW Drawer	37/8x16 ³ / ₈ x15 ⁷ / ₈	SXRS4.5	
6" (152mm) SW Drawer	5 ³ / ₈ x16 ¹ / ₄ x15 ³ / ₄	SXRS6	SXRS6-LK
7.5" (191mm) SW Drawer	6 ⁷ / ₈ x16 ¹ / ₄ x15 ³ / ₄	SXRS7.5	
9" (230mm) SW Drawer	8 ³ / ₈ x16 ¹ / ₄ x15 ³ / ₄	SXRS9	SXRS9-LK
10.5" (267mm) SW Drawer	9 ⁷ / ₈ x16 ¹ / ₄ x15 ³ / ₄	SXRS10.5	
12" (305mm) SW Drawer	11 ³ / ₈ x16 ¹ / ₄ x15 ³ / ₄	SXRS12	



Removable drawer totes allow for exchange or convenient access outside of cart

Drawer Pulls (one required per drawer) To specify color for drawer pull, order following catalog numbers for each drawer:

Dark Taupe SXRDP-TP	White SXRDP-WH	Code Blue SXRDP-CB	Red SXRDP-RE	Orange SXRDP-OR	Green SXRDP-GR	Yellow SXRDP-YL	Slate Blue SXRDP-BL	Violet SXRDP-VL	Pink SXRDP-PK	Black SXRDP-BK

Description	Dimensions Height/Length in.	Cat. No.
Drawer Label Holders		
Label Kits (10 Pieces Per Kit)	3/4" X 11" (19 x 279mm)	SXRLABKIT

Note: Each drawer face has a 1/2 x 18 3/8" polished area allowing for secure adhesion of DYMO and Zebra labels (not supplied by Metro).



SXRLABKIT



DYMO and Zebra Labels (not supplied by Metro)

Drawer Accessories for Drawers and Full Extension Totes

Description	Product Detail (Qty.) in.	Cat. No.
Drawer Divider Kits		
Divider Clip to Attach Loose Short Divider-end to Long Divider, 1 per Short Divider (Qty. 2)		T-CLIP
3" (76mm) Drawer Divider Kit	(2) 16.8 & (6) 5	SXR3DIV
3" (76mm) Drawer Short Dividers	(3) 5	SXR3SDIV
3" (76mm) Drawer Long Dividers	(2) 16.8	SXR3LDIV
Egg Crate Style 3" (76mm) Drawer Divider Kit	(5) 16.8 & (10) 8	SXR3DVR
6" (76mm) Drawer Divider Kit	(2) 16.8 & (6) 5	SXR6DIV
6" (76mm) Drawer Short Dividers	(3) 5	SXR6SDIV
6" (76mm) Drawer Long Dividers	(2) 16.8	SXR6LDIV
Egg Crate Style 6"/9" (152/230mm) Drawer Divider Kit	(5) 16.8 & (10) 8	SXR6DVR

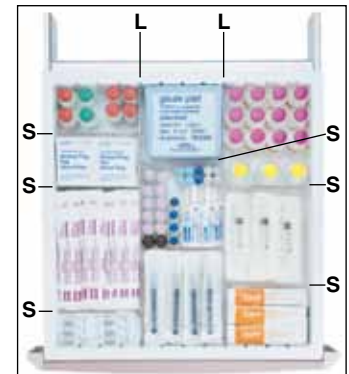

Drawer dividers are available to organize your supplies for easy access.

Description	Inside Dimensions (Height/Width/Length) (in.) (mm)	Non-Locking Cat. No.	Locking Cat. No.
Additional Starsys Totes – Totes provide complete containment for smaller items.			
3" (76mm) Drawer Tote	2 ³ / ₈ x18 ¹ / ₄ x17 ¹ / ₂ 70x464x445	SXR3TOTE	SXR3-LKTOTE
6" (152mm) Drawer Tote	5 ³ / ₈ x18 ¹ / ₄ x17 ¹ / ₂ 146x464x445	SXR6TOTE	SXR6-LKTOTE
9" (229mm) Drawer Tote	8 ¹ / ₂ x18 ¹ / ₄ x17 ¹ / ₂ 216x464x445	SXR9TOTE	SXR9-LKTOTE



Drawer Totes

To configure a Starsys unit to your exact specifications, please visit www.metroconfigurator.com



SXR243

Corner Accessories

Description	Dimensions — Inches (millimeters)	Cat. No.
Articulating Laptop Arm	18" Extension, 10" Vertical Range	SXR LAP
Articulating LCD Monitor Arm	Includes: 75 & 100mm VESA adapters	SXR MON
Articulating Tablet PC Arm	Rotates for Writing or Drawing	SXR TAB
Articulating Arm Mounting Pole*	Order with Laptop, Monitor or Tablet Arms	SXR-ARMPOLE
Hospital Grade Power Strip & Cord Wrap	6 Outlets, 15" Cord	SXR595
I.V. Utility Pole	Attaches directly to left or right rear cart corner	SXR IV
Peel Pouch/Catheter Holder-18"	18H (457) x 6W (152) x 3D (76)	SXR240
Peel Pouch/Catheter Holder-28"	27H (686) x 6W (152) x 3D (76)	SXR243

*Mounting pole ordered separately.



Accessorized Pods on Starsys cart

Side Pods — All side pods are 30"H x 19.5"W x 6"L (762 x 483 x 152mm)

Description	Cat. No.
Fixed Side Pod (Non-Locking)	SXRPOD
Fixed Side Pod (with Top-Locking Tilt Bin)*	SXRPODK1
Fixed Side Pod (with 3-Locking Tilt Bins)**	SXRPODK3
Left Swing-out Side Pod (Non-Locking)	SXRPODSL
Left Swing-out Side Pod (with Top-Locking Tilt Bin)*	SXRPODSLK1
Left Swing-out Side Pod (with 3 Locking Tilt Bins)**	SXRPODSLK3
Right Swing-out Side Pod (Non-Locking)	SXRPODSR
Right Swing-out Side Pod (with Top Locking Tilt Bin)*	SXRPODSRK1
Right Swing-out Side Pod (with 3-Locking Tilt Bins)**	SXRPODSRK3

*Top Tray with Dividers and Tilt Bin included.

**Top Tray with Dividers and 3 Tilt Bins included.



SXR GAS

Side Pod Accessories

Description	Dimensions — Inches (millimeters)	Cat. No.
Chart Holder	9 ⁹ / ₁₆ H (242) x 11 ¹ / ₂ W (292) x 4 3/4L (121)	SXRCHRT
Containment Shelf Ledge	1 ¹ / ₂ H (38) 16L (406) x 3 ¹ / ₂ D (89)	SXRPODL DGE
Cup Holder ²	Cup Sizes: 1 ³ / ₈ (35), 2 (51), 2 ¹ / ₂ (64)	SXRCUP
Gas Tank Holder ³	Holds C, D and E Tanks	SXRGAS-H
Glove Box Holder — Single	6 ¹ / ₈ H (156) x 10 ¹ / ₈ W (258) x 4L (102)	FL236
Glove Box Holder — Triple	18 ¹ / ₄ H (464) x 10 ¹ / ₈ W (258) x 5 ¹ / ₂ L (140)	FL237
Lockable Sharps Container & Glove Box	18 ¹ / ₄ H (464) x 13W (330) x 5 ¹ / ₂ L (140)	SXR251
Lockable Sharps Replacement Containers	20/Pack, 5 Qt. (4.7L) Capacity	SXR MF252
Sharps Container Holder	9.3H (236) x 8W (203) x 3L (76)	SXRSHRPS
Tilt Out Bin	7 ¹ / ₂ H (191) 16L (406) x 3 ¹ / ₂ D (89)	SXRPODBIN
Top Tray (with 3 Dividers) ¹	2 ¹ / ₂ H (57) x 16 ⁷ / ₈ W (429) x 4 ³ / ₈ L (111)	SXRPODTRY
Unit Shelf	4 ¹ / ₂ D (115) x 16 ⁷ / ₈ D (429) x 16 ⁷ / ₈ W (429)	SXRPOD SHLF
Waste Basket & Holder	Holder: 15.5H (394) x 8W (203) x 3L (76)	SXRBSKT-H
Waste Basket Only	12 ¹ / ₄ H (311) x 11 ¹ / ₄ W (286) x 8 ¹ / ₄ D (210)	SXRBSKT

¹Attached to top of Unit Shelf (SXRPOD SHLF).

²Attaches to top of Unit Shelf (SXRPOD SHLF).

³One or two allowed on Fixed Non-Locking Pods Only.



SXRPODL DGE



SXRPODBIN

Starsys Carts are built to exact customer specifications, therefore, they are non-cancelable, non-returnable.

Side Accessory Bracket

Description	Dimensions — Inches (millimeters)	Cat. No.
Side Accessory Bracket	4 ³ / ₈ H (111) x 19 ³ / ₈ W (492)	SXR205



SXR205, SXR251

Side Accessory Bracket Accessories

Description	Dimensions — Inches (millimeters)	Cat. No.
Chart Holder ¹	9 ⁹ / ₁₆ H (242) x 11 ¹ / ₂ W (292) x 4 ³ / ₄ L (121)	SXRCHRT
Gas Tank Holder — Single ²	Holds C, D and E Tanks	SXRGAS-H
Glove Box Holder — Single ¹	6 ¹ / ₈ H (156) x 10 ¹ / ₈ W (258) x 4L (102)	FL236
Glove Box Holder — Triple ²	18 ¹ / ₄ H (464) x 10 ¹ / ₈ W (258) x 4L (102)	FL237
Lockable Sharps Container & Glove Box ¹	18 ¹ / ₄ H (464) x 13W (330) X 5 ¹ / ₂ L (140)	SXR251
Lockable Sharps Replacement Containers	20/Pack, 5 Qt. (4.7L) Capacity	SXRMF252
Scope Cabinet (2 Hooks)*	48H (1220) x 9W (229) x 6L (152)	SXR245
Scope Cabinet (4 Hooks)*	48H (1220) x 16W (406) x 6L (152)	SXR246
Sharps Container Holder ¹	9.3H (236) x 8W (203) x 3L (76)	SXRSHRPS
Side Bins (3-Pk) ³	4 (102) x 4 ¹ / ₂ (114) x 18 ³ / ₈ (254)	MBP216
Waste Basket & Holder ¹	Holder: 15.5H (394) x 8W (203) x 3L (76)	SXRBSKT-H
Waste Basket Only	12 ¹ / ₄ H (311) x 11 ¹ / ₄ W (286) x 8 ¹ / ₄ D (210)	SXRBSKT



SXR246

*Accessory Bracket(s) included.
¹Order with (1) SXR205 Accessory Bracket.
²Order with (2) SXR205 Accessory Brackets.
³Order with (3) SXR205 Accessory Brackets

Other Side Accessories

Description	Dimensions — Inches (millimeters)	Cat. No.
Extended Handle	4H (102) x 21 ¹ / ₂ W (546) x 4 ¹ / ₄ L (108)	SXREHAN
Extended Handle (Field Retrofit)	4H (102) x 21 ¹ / ₂ W (546) x 4 ¹ / ₄ L (108)	SXREHAN-KD
Pullout Writing Surface (Left Side)	17.5"W (445) x 15.75"L (400); (25 lb. cp.)	SXRPULLOUTL
Pullout Writing Surface (Right Side)	17.5"W (445) x 15.75"L (400); (25 lb. cp.)	SXRPULLOUTR



SXRPULLOUTL

Overbridge and Accessories

Description	Cat. No.
(A) Overbridge Assembly with two Hanger Rails**	SXRSOB
Overbridge Assembly with no Hanger Rails	SXRSOB-1000
(B) Hanger Rail (2 ³ / ₁₆ " [55mm] H.x1" [25.4mm] W.x19 ¹ / ₂ " [495mm] L. usable space	SXROBSRAIL
Overbridge with Top Shelf and Hanger Rail	SXR515
Overbridge with 2 Shelves	SXR520
Overbridge Shelf***	SXR560
Utility Pole Including Universal Clamp (Attaches to Overbridge)	SXR566
Universal Clamp	SXR570
Short Utility Hook (package of 4) (3 ¹ / ₂ " [89mm] usable length)	SXR571
Laryngoscope Blade/Specimen Holder	SXR575
(C) Half-Size Metal Utility Bin (5 ¹ / ₂ " [140mm] H.x5 ¹ / ₂ " [140mm] W.x5 ³ / ₄ " [146mm] L.)	SXR581
(D) Full-Size Metal Utility Bin (5 ¹ / ₂ " [140mm] H.x5 ¹ / ₂ " [140mm] W.x11 ⁵ / ₈ " [292mm] L.)	SXR582
Label/Tape Dispenser	SXR583
Wire Supply Basket (7" [178mm] H.x5" [127mm] W.x17" [432mm] L.)	SXR585
(E) Utility Bin with Cover (Package of 6)	SXR586
†† Sharps Container Bracket	LEC9800
Tilt Bin 3 Units with Brackets	SXRMF543
Tilt Bin 4 Units with Brackets	SXRMF544
Tilt Bin 6 Units with Brackets	SXRMF546



SXREHAN



SXRSOB Overbridge Assembly (shown with optional accessories)

** Maximum weight capacity for overbridge assembly is 40 lbs. (18.1kg).
*** Maximum weight capacity for overbridge shelf is 40 lbs. (18.1kg).
† Mounts to universal clamp in addition to hanger rail.
†† Mounts to I.V. pole or utility pole.

To configure a Starsys unit to your exact specifications, please visit www.metroconfigurator.com



4 Level Cassette



Bins



Double-Wide, Double Sided Medication Cassette Transfer Cart Cat. No. SXRD43TRAN (shown with cassettes and bins, sold separately, see above)

Components — Polymer

Description	No. of Bins Per Level	Overall Dimensions		Cat. No.
		Height/Width/Length (in.)	Height/Width/Length (mm)	
Cassettes and Bins				
1 Level Cassette Body		5 ¹⁵ / ₁₆ X11 ³ / ₄ X19 ³ / ₈	151x298x492	SXRCASB1
2 Level Cassette Body		8 ¹⁵ / ₁₆ X11 ³ / ₄ X19 ³ / ₈	277x298x492	SXRCASB2
3 Level Cassette Body		11 ¹⁵ / ₁₆ X11 ³ / ₄ X19 ³ / ₈	303x298x492	SXRCASB3
4 Level Cassette Body		14 ¹⁵ / ₁₆ X11 ³ / ₄ X19 ³ / ₈	379x298x492	SXRCASB4
5 Level Cassette Body		17 ¹⁵ / ₁₆ X11 ³ / ₄ X19 ³ / ₈	456x298x492	SXRCASB5
3" (76mm) wide Cassette Bin	6	2 ⁹ / ₁₆ X11 ¹⁵ / ₁₆ X2 ¹¹ / ₁₆	65x303x68	SXRBINSB3
4 ¹ / ₂ " (114mm) wide Cassette Bin	4	2 ⁹ / ₁₆ X11 ¹⁵ / ₁₆ X4 ¹ / ₁₆	65x303x103	SXRBINSB4
6" (152mm) wide Cassette Bin	3	2 ⁹ / ₁₆ X11 ¹⁵ / ₁₆ X5 ¹ / ₂	65x303x140	SXRBINSB6
8" (203mm) wide Cassette Bin	2	2 ⁹ / ₁₆ X11 ¹⁵ / ₁₆ X8	65x303x203	SXRBINSB8

Note: Bins are shipped with one ID card.

Description	Cat. No.
Bin Accessories	
Cassette Bin Divider Kit (20 dividers)	SXRBINDIV
Cassette Label Kit (includes label strips in Mauve, Slate Blue and Jade for identification of bins)	SXRCASLAB
Cassette Bin Labels (5 sheets of Slate Blue bin labels — 18 of each size per sheet)	SXRBINLAB-BL
Cassette Bin Labels (5 sheets of Jade bin labels — 18 of each size per sheet)	SXRBINLAB-GR
Cassette Bin Labels (5 sheets of Mauve bin labels — 18 of each size per sheet)	SXRBINLAB-RD

SXRBINDIV divides up to 4 bins.
 SXRCASLAB includes 3 sheets of labels. One sheet per color. Each sheet contains 18 labels for each size bin. It also includes 18 patient ID bin cards for each size bin and 4 cassette ID labels.

Medication Cassette Transfer Carts

Description	Overall Dimensions		Inside Height		Approx. Pkd. Wt.		Cat. No.
	Height/Width/Length (in.)	Height/Width/Length (mm)	(in.)	(mm)	(lbs.)	(kg)	
Single-Wide, Double-Sided*							
40" (1016mm) Single	39 ³ / ₄ X24 ⁷ / ₈ X22 ¹¹ / ₁₆	1010x632x576	30 ¹ / ₄	768	150	68	SXRS40TRAN
43" (1092mm) Single	42 ³ / ₄ X24 ⁷ / ₈ X22 ¹¹ / ₁₆	1086x632x576	33 ³ / ₄	845	150	68	SXRS43TRAN
46" (1168mm) Single	45 ³ / ₄ X24 ⁷ / ₈ X22 ¹¹ / ₁₆	1162x632x576	36 ¹ / ₄	921	157	71	SXRS46TRAN
Double-Wide, Double Sided*							
40" (1016mm) Double	39 ³ / ₄ X24 ⁷ / ₈ X42 ¹ / ₂	1010x632x1080	30 ¹ / ₄	768	170	77	SXRD40TRAN
43" (1092mm) Double	42 ³ / ₄ X24 ⁷ / ₈ X42 ¹ / ₂	1086x632x1080	33 ³ / ₄	845	176	80	SXRD43TRAN
46" (1168mm) Double	45 ³ / ₄ X24 ⁷ / ₈ X42 ¹ / ₂	1162x632x1080	36 ¹ / ₄	921	181	82	SXRD46TRAN

*Cassette storage available on both front and back of cart.

Starsys™ Single Bin Access Cassette System

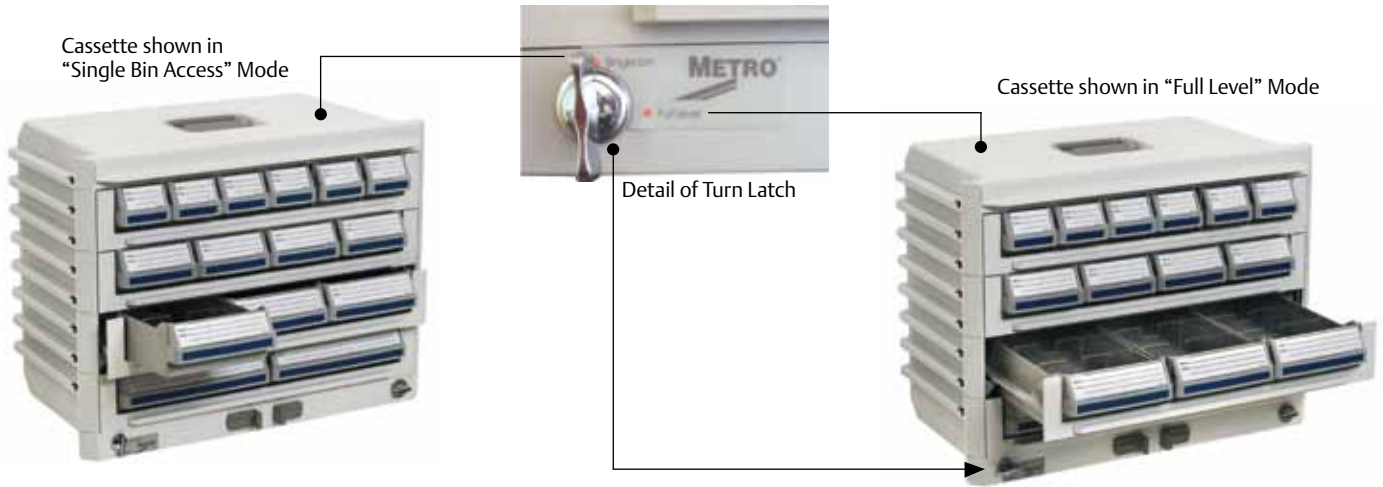

Starsys Carts are built to exact customer specifications, therefore, they are non-cancelable, non-returnable.